

ADJUSTABLE STEAM & DRY IRON



MODEL WST5002ZE

OWNER'S MANUAL



Westinghouse

IMPORTANT SAFEGUARDS

When using your flat iron, basic safety precautions should always be followed including the following:

1. Read all instructions.
2. Use iron only for its intended use.
3. To protect against a risk of electric shock, do not immerse the iron in water or other liquids.
4. The iron should always be turned to off before plugging or unplugging from outlet. Never yank cord to disconnect from outlet; instead, grasp plug and pull to disconnect.
5. Do not allow cord to touch hot surfaces. Let iron cool completely before putting away. Loop cord loosely around iron when storing.
6. Always disconnect iron from electrical outlet when filling with water or emptying and when not in use.
7. Do not operate iron with a damaged cord or if the iron has been dropped or damaged. To avoid the risk of electric shock, do not disassemble the iron. Incorrect reassembly can cause a risk of electric shock when the iron is used. Contact Consumer Service for examination and repair.
8. Close supervision is necessary for any appliance being used by or near children. Do not leave iron unattended while connected or on an ironing board.
9. Burns can occur from touching hot metal parts, hot water, or steam. Use caution when you turn a steam iron upside down---there may be hot water in the reservoir.

SPECIAL INSTRUCTIONS

1. To avoid a circuit overload, do not operate another high wattage appliance on the same circuit.
2. If an extension cord is absolutely necessary, a 15-ampere cord should be used. Cords rated for less amperage may overheat. Care should be taken to arrange the cord so that it cannot be pulled or tripped over.

SAVE THESE INSTRUCTIONS

For Household Use Only

ADDITIONAL IMPORTANT SAFEGUARDS

CAUTION HOT SURFACES: This appliance generates heat and escaping steam during use. Proper precautions must be taken to prevent the risk of burns, fires or other damage to persons or property.

1. All users of this appliance must read and understand this Owner's Manual before operating or cleaning this appliance.
2. The cord to this appliance should be plugged into a 120V AC electrical outlet only.
3. If this appliance begins to malfunction during use, immediately unplug the cord. Do not use or attempt to repair the malfunctioning appliance.
4. Do not leave this appliance unattended during use.

POLARIZED PLUG

This appliance has a polarized plug (one blade is wider than the other). To reduce the risk of electric shock, this plug is intended to fit into a polarized outlet only one way. If the plug does not fit fully in the outlet, reverse the plug. If it still does not fit, contact a qualified electrician. Do not attempt to modify the plug in any way.

ELECTRIC POWER

If the electrical circuit is overloaded with other appliances, your appliance may not operate properly. It should be operated on a separate electrical circuit from other appliances.

GETTING TO KNOW YOUR WESTINGHOUSE WST5002ZE ADJUSTABLE STEAM & DRY IRON

PRODUCT MAY VARY SLIGHTLY FROM ILLUSTRATION.

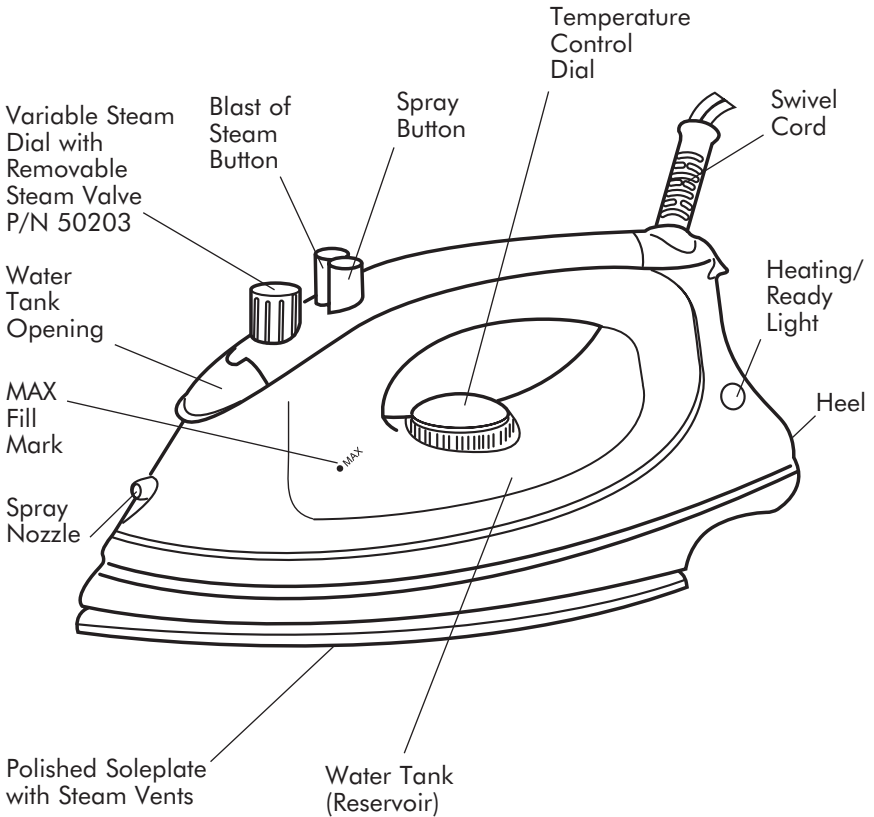

BEFORE USING FOR THE FIRST TIME

Carefully unpack your Iron and remove all packaging materials and any adhesive stickers from the Soleplate. Make sure all adhesive is removed by rubbing Soleplate with a damp cloth. To remove any dust that may have accumulated on the Iron during packaging, simply wipe with a clean, damp cloth. Do not use abrasive cleansers. Do not put the Iron, cord or plug in water.

NOTE: Before you use your Iron for the first time, you should flush the Soleplate steam vents to ensure that no stain is transferred onto fabric from residue possibly left in the vents from the manufacturing process. To do this, see SELF-CLEANING/FLUSHING section for detailed instructions.

OPERATING INSTRUCTIONS

FABRIC CHART

	Fabric	Setting
NO STEAM	Acrylic Acetate	ACRYLIC
	Silk Nylon	SILK
	Rayon	RAYON
STEAM	Wool Polyester	WOOL
	Cotton Triacetate	COTTON
	Linen	LINEN

FOR BEST RESULTS

1. Check garment labels for the temperature and steam setting recommended by the fabric manufacturer.
2. To prevent damaging garments from too hot of an Iron, it is best to first iron garments that require a low temperature. If you should need to switch from a high setting to a lower temperature, for example, "••••" to "••", allow the Iron about 5 minutes to reach the lower temperature.

OPERATING INSTRUCTIONS (Cont.)

FOR BEST RESULTS (Cont.)

3. If you are unsure of a garment's fabric content, start on a low setting and test the Iron on an area of the garment that does not show, such as a seam. Gradually increase the heat setting until wrinkles remove without damaging the fabric.
4. To prevent shine, iron dark garments, or those made of silk, acetate or rayon, inside out.

WARNING: To prevent fire, do not leave Iron unattended while plugged in.

IRONING WITHOUT STEAM

The Iron can be used with or without water in the Tank. However, it is best to avoid having the Tank too full of water while ironing without steam.

1. Position Temperature Control Dial to the lowest MIN setting.
2. Turn the Variable Steam Dial to ~~☒~~ NO STEAM.
3. Stand the Iron on its Heel in an upright position on an iron-safe surface and plug into a 120V AC outlet.
4. Turn the Temperature Control Dial to the desired setting.
5. When the Heating/Ready Light turns off, the Iron has reached the desired temperature.
6. If desired, you may still use the Spray Button or Blast of Steam Button as long as there is water in the Tank.
7. When finished, turn Temperature Control Dial to the lowest MIN setting and unplug. Allow the Iron to cool before cleaning the exterior or before storing.



NOTE: During ironing, the Heating/Ready Light may turn on again which indicates that the Iron is heating up to maintain the proper temperature.

CAUTION: If the Iron has been used for a long period of time and is hot, DO NOT fill it with water.

OPERATING INSTRUCTIONS (Cont.)

IRONING WITH STEAM

When using as a Steam Iron, be sure the temperature setting on the Temperature Control Dial is within the WOOL; COTTON; or LINEN setting to avoid water spotting on a garment.

1. Position Temperature Control Dial to the lowest MIN setting.
2. With the unit UNPLUGGED, fill the Iron's Water Tank to the MAX Fill Mark.
3. Stand the Iron on its Heel in an upright position on an iron-safe surface and plug it into a 120V AC outlet.
4. Turn the Temperature Control Dial to the WOOL; COTTON; or LINEN setting.
5. Allow approximately 2 minutes for the Iron to reach the desired temperature.
6. Turn the Variable Steam Dial to  for Moderate Steam or  for Maximum Steam. As soon as the Iron is held horizontally, steam will flow through the Vents. If the iron fails to steam, gently tap the Soleplate on the Iron surface. Placing the Iron on its Heel in an upright position interrupts the flow of steam.
7. When finished, turn the Temperature Control Dial to MIN and unplug. Allow Iron to cool fully before cleaning the exterior of the Iron or before storing.

CAUTION: Avoid coming into contact with escaping steam.

CAUTION: If the Iron has been used for a long period of time and is hot, DO NOT fill it with water. Allow to cool, then refill and resume ironing.

BLAST OF STEAM

The "Blast of Steam" is very useful for removing stubborn creases from fabrics.

1. Fill Water Tank and set Temperature Control Dial to either the WOOL; COTTON; or LINEN setting.
2. Press down on the Blast of Steam  Button.

NOTE: If the temperature setting is too low, water may drip from Soleplate. To obtain a good flow of steam, press Blast of Steam Button several times, pausing 5 seconds between each blast to allow Iron to reheat.

OPERATING INSTRUCTIONS (Cont.)

USING THE SPRAY BUTTON

For a mist of water to moisten dry and difficult fabrics such as linen, cotton or wool, or to handle stubborn wrinkles, press the Spray Button.

 The Spray Function is also handy to moisten creases accidentally ironed into the fabric.

NOTE: You may have to pump the Spray Button several times the first time you use the Iron in order to start the spraying action.

FILLING THE WATER TANK

1. **Unplug the Iron before filling.**
2. Turn the Variable Steam Dial to  NO STEAM setting.
3. Hold the Iron in horizontal position (Soleplate down).
4. Using a measuring cup, slowly pour water into the Water Tank Opening.
5. Check see-through Water Tank to see if Iron is filled to MAX Fill Mark.

NOTE: Your Iron is designed to use tap water. However, if your water is very hard, it is recommended that you use distilled water. DO NOT use water from home water softening systems because such water may contain minerals that may harm the Iron.

CAUTION: Never fill Iron with fabric conditioner, starches, or any other solution as these will damage the steam mechanism. Do not use contaminated water.

EMPTYING THE WATER TANK

The Water Tank should be emptied after each use.

1. Unplug Iron from the electrical outlet.
2. While the Iron is still warm, hold the Iron over a sink and allow the Iron to drain by tipping the point of the Iron down.
3. Gently shake the Iron to loosen any water drops that may be trapped. The warmth of the Iron should dry out any remaining water.



NOTE: If you empty the Water Tank after the Iron has cooled, set the Iron in an upright position on its Heel. Plug it in and set the Temperature Control Dial to MAX heat for 2 minutes. Then unplug the Iron and let it cool before storing.

USER MAINTENANCE INSTRUCTIONS

This appliance requires little maintenance and contains no user serviceable parts. Do not try to fix it yourself. Refer it to qualified service personnel if servicing is needed.

SELF-CLEANING/FLUSHING

Flushing the Iron is advised after every 5 uses to prevent harmful mineral build-up that can clog the Iron and prevent it from heating and steaming properly.

1. With the Iron unplugged, position the Temperature Control Dial to the lowest MIN setting.
2. Turn the Variable Steam Dial to  NO STEAM.
3. Fill the see-through Water Tank to the MAX Fill Mark.
4. Plug the Iron into a 120V AC outlet and set the Temperature Control Dial to its highest setting “ • • • ” Linen. Let the Iron heat for 2 minutes.
5. Turn the Variable Steam Dial to  for Self-Clean setting.
6. Place a hand towel over the ironing surface.
7. Hold the Iron horizontally 2 inches above a towel, allowing steam to flow through the Vents for 1-2 minutes. You may also press the Blast of Steam Button several times, pausing 5 seconds between blasts to allow the Iron to reheat.
8. Pass the Iron over a damp cloth to clean the Soleplate.
9. When finished, turn the Temperature Control Dial to the lowest MIN setting and unplug from outlet. Allow the Iron to cool completely before cleaning the exterior of the Iron or before storing.
10. Use a cloth to wipe the exterior of the Iron before storing.

USER MAINTENANCE INSTRUCTIONS

(Cont.)

TO CLEAN SOLEPLATE

The Iron should be fully cooled before Soleplate cleaning begins. Make sure the Iron is unplugged before cleaning. Empty the Water Tank of any remaining water. Apply a small amount of mild cleaner to a damp cloth. Gently rub Soleplate, then wipe with a moist cloth. **NEVER USE** scouring pads or abrasive cleaners on the Soleplate, as this may scratch the surface.

Wipe all other surfaces with a slightly damp cloth. Never allow water or any other liquid to get into the unit, except when filling the Water Tank. **NEVER** put any chemical cleaning agents or solvents in the Water Tank.



BEFORE USING AGAIN, preheat and move Iron over an old cloth several times to remove any residue from the Soleplate.

CLEANING THE STEAM VALVE

The variable steam dial/valve is removable to clean build-up scale which can result in poor steam performance. Cleaning of the steam valve is only necessary if you notice a reduction in steam performance.

Always disconnect from electrical outlet when cleaning the steam valve.

TO REMOVE STEAM VALVE

1. Empty the water tank and let the Iron cool down. Place the Iron on the Soleplate.
2. Firmly turn the **STEAM** dial counter-clockwise to the  icon. It will pop up.
3. Pull up to remove steam valve fully. Wipe tip gently to clean.
4. **To replace:** Align  with the indicator arrow. Push down and turn clockwise.

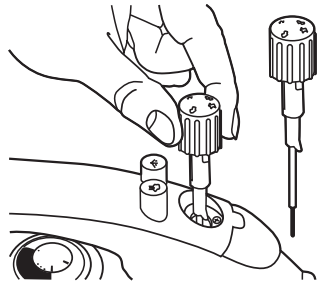

CAUTION: Do not pour water into the steam valve hole.

USER MAINTENANCE INSTRUCTIONS

(Cont.)

STORAGE

Unplug appliance and allow to cool. STORE IN UPRIGHT POSITION ON HEEL REST. Never store Iron lying on the Soleplate. Never store it while it is hot or still plugged in. Never wrap cord tightly around the appliance. Do not put any stress on the cord where it enters the unit, as it could cause the cord to fray and break.

LIMITED ONE-YEAR WARRANTY

Warranty Coverage: This product is warranted to be free from defects in materials or workmanship for a period of one (1) year from the original purchase date. This product warranty is extended only to the original consumer purchaser of the product and is not transferable. For a period of one (1) year from the date of original purchase of the product, our Repair Center will, at its option, either (1) repair the product or (2) replace the product with a reconditioned comparable model. These remedies are the purchaser's exclusive remedies under this warranty.

Warranty Service: To obtain warranty service, you must call our warranty service number at 1-800-233-9054 for return instructions on how to deliver the product, in either the original packaging or packaging affording an equal degree of protection to the Repair Center specified below. You must enclose a copy of your sales receipt or other proof of purchase to demonstrate eligibility for warranty coverage.

To return the appliance, ship to:

ATTN: Repair Center
708 South Missouri Street
Macon, MO 63552 USA

To contact us, please write to, call, or email:

Consumer Relations Department
PO Box 7366
Columbia MO 65205-7366 USA
1-800-233-9054
E-mail:
consumer_relations@toastmaster.com

What Is Not Covered: This warranty does not cover damage resulting from misuse, accident, commercial use, improper service or any other damage caused by anything other than defects in material or workmanship during ordinary consumer use. This warranty is invalid if the serial number has been altered or removed from the product. This warranty is valid only in the United States and Canada.

LIMITATION ON DAMAGES: THERE SHALL BE NO LIABILITY FOR ANY INCIDENTAL OR CONSEQUENTIAL DAMAGES FOR BREACH OF ANY EXPRESS OR IMPLIED WARRANTY OR CONDITION ON THIS PRODUCT.

DURATION OF IMPLIED WARRANTIES: EXCEPT TO THE EXTENT PROHIBITED BY APPLICABLE LAW, ALL IMPLIED WARRANTIES AND CONDITIONS, INCLUDING, WITHOUT LIMITATION, IMPLIED WARRANTIES AND CONDITIONS OF MERCHANTABILITY AND FITNESS FOR A PARTICULAR PURPOSE OR USE ON THIS PRODUCT ARE LIMITED IN DURATION TO THE DURATION OF THIS WARRANTY.

Some jurisdictions do not allow the exclusion or limitation of incidental or consequential damages, or allow limitations on how long an implied warranty lasts, so the above limitations or exclusions may not apply to you. This warranty gives you specific legal rights and you may have other rights under the laws of your jurisdiction.

For more information on our products, visit our website: www.maxim-toastmaster.com.